

# ➤ Instructions

## Thule Touring

6341, 6342, 6346, 6347, 6348

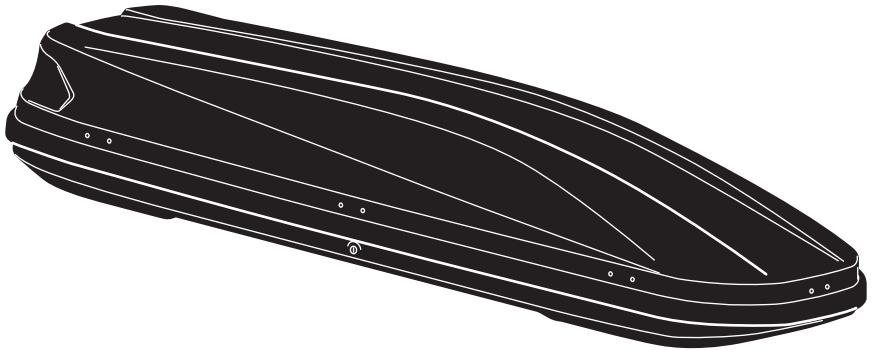

- EN** Roof box for roof-mounted racks  
**DE** Dachbox für Dachträger  
**FR** Coffre pour barres de toit  
**NL** Dakkoffer  
**IT** Box da tetto per portapacchi da installare sul tetto  
**ES** Cofre portaequipajes para barras de techo  
**PT** Caixa bagageira para barras de tejadilho  
**SV** Takbox för takmonterade räckor  
**DK** Tagboks til tagbjælter  
**NO** Takboks til takmonterte stativer  
**FI** Katolle asennettaviin telineisiin sopiva kuljetuslaatikko  
**ET** Katusele paigaldatav katuseboks  
**LV** Jumta kaste uz jumta uzstādāmiem bagāžniekiem  
**LT** Ant stogo tvirtinamų skersinių bagažinės  
**PL** Box dachowy na bagażnik montowany na dachu  
**RU** Грузовой бокс на крышу автомобиля  
**UK** Вантажний бокс для багажників для даху  
**BG** Кутия за багаж за релси, монтирани върху покрива  
**CS** Střešní box pro montáž na střechu  
**SK** Strešný box na strešné nosiče  
**SL** Strešni kovček za strešne prtljažnike  
**HR/BIH** Krovna kutija za krovne nosače  
**RO** Portbagaj de acoperiș pentru cadru de bare montate pe acoperiș  
**HU** Tetőre szerelhető tetőbox  
**EL** Μπαγκάζιέρα οροφής για μπάρες οροφής  
**TR** Araç üstüne bağlanan raflar için tavan kutusu  
**HE** תא חפצים לגג הרכב  
**AR** صندوق سقف للحوامل المثبتة على السقف  
**ZH** 用于车顶架的车顶箱  
**JA** ルーフマウント型ラック用ルーフボックス  
**KO** 루프 장착 랙 루프 박스  
**TH** กล่องบนหลังคาสำหรับแร็คหลังคา



**CITY CRASH**  
Complies with ISO norm

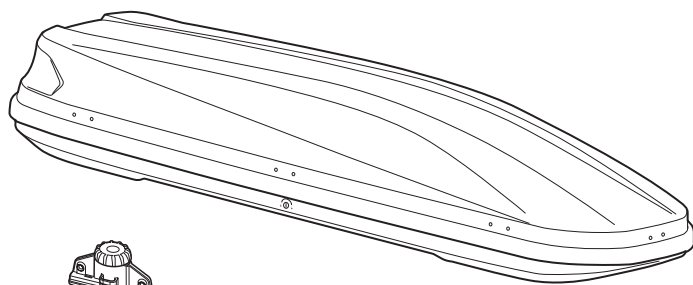
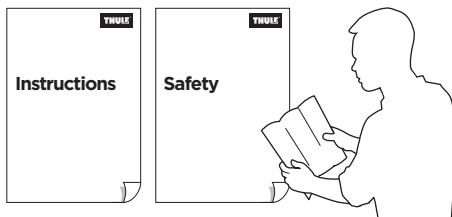

**x1**

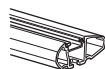
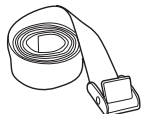

Thule WingBar Evo

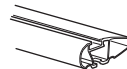

Thule WingBar

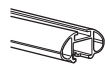

Thule AeroBar



Thule SlideBar



Thule Squarebar

**i**

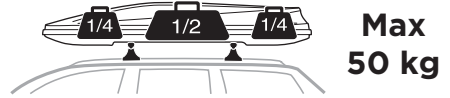

Touring 100/S	10 kg
Touring 200/M	13 kg
Touring 600/Sport	12 kg
Touring 700/Alpine	15 kg
Touring 780/L	15 kg

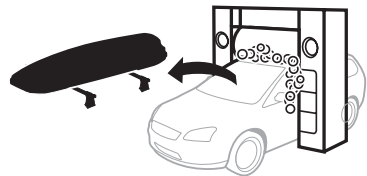
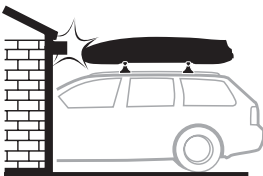
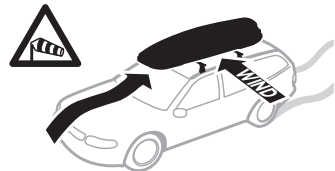
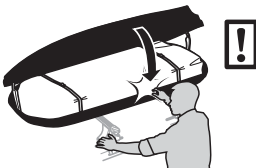
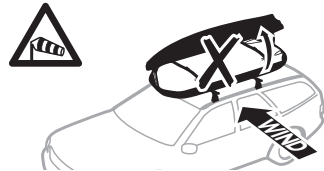
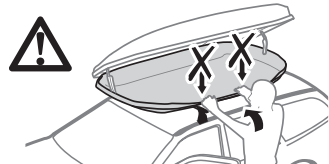
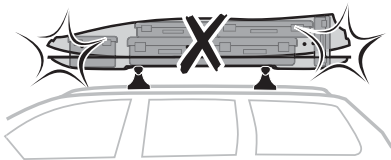
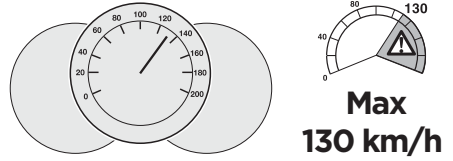

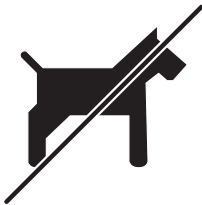
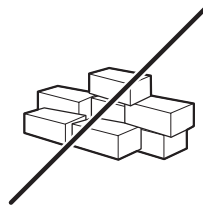
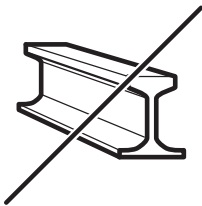
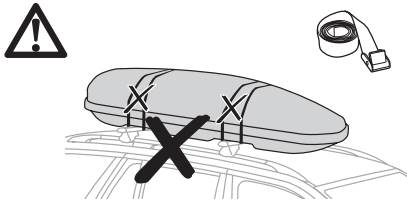
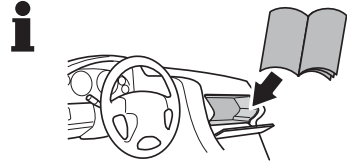
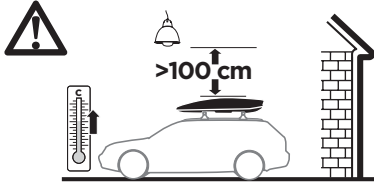
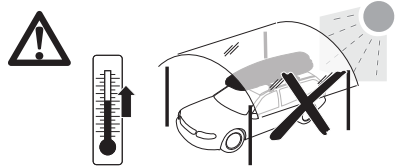
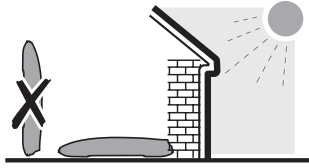



# Thule T-track Adapter

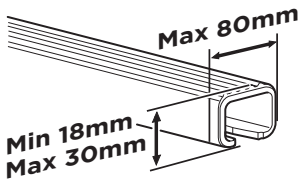

696400

697400

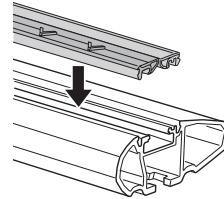
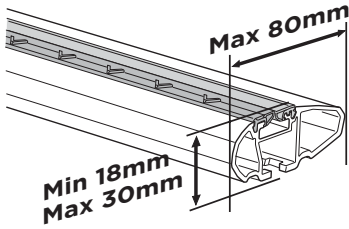
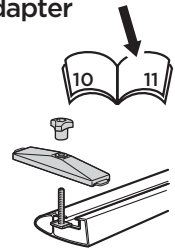

	D Min*	D Max*	Wf*	Wr*	H*	R Min*
Touring 100/S	515	925	763	740	406	937
Touring 200/M	545	955	702	697	413	1149
Touring 600/Sport	545	955	525	528	359	1184
Touring 700/Alpine	545	955	587	583	382	1431
Touring 780/L	545	955	673	673	400	1250

\*mm

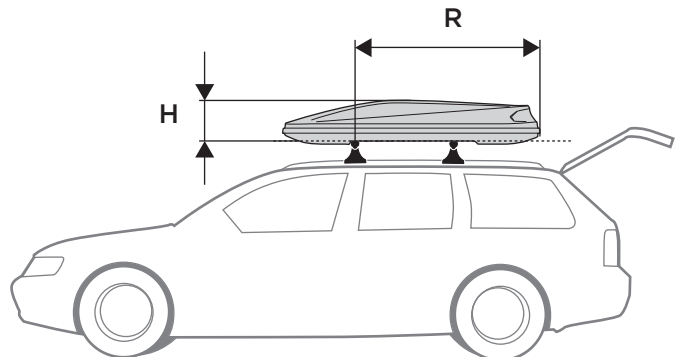
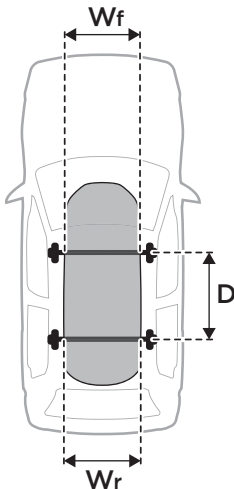

1

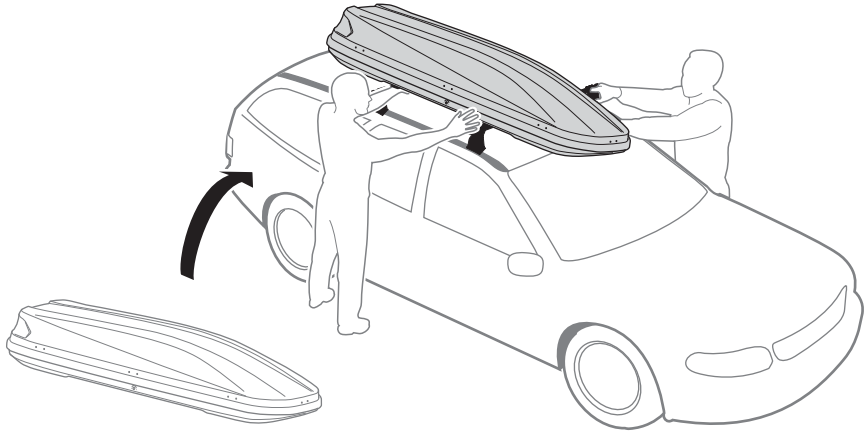

2

a

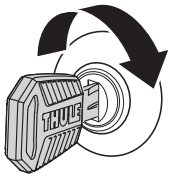

b

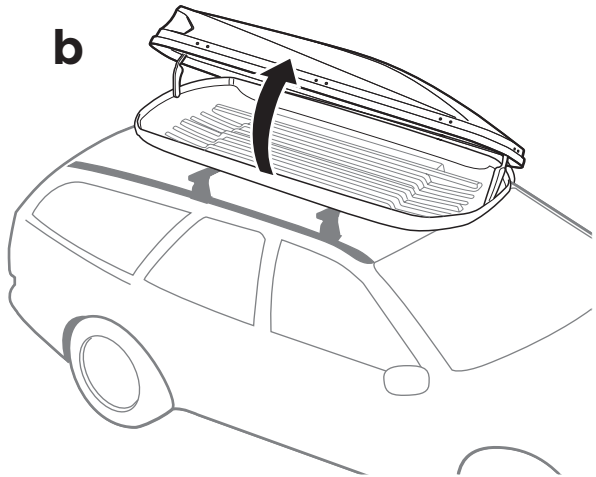

3

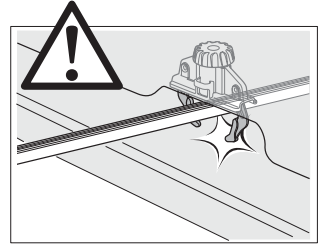
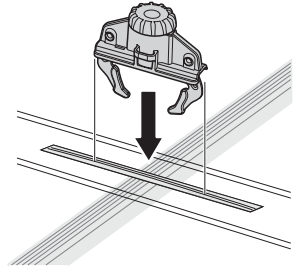
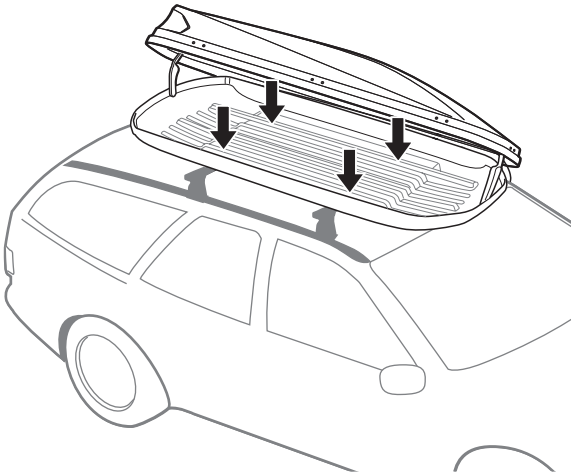
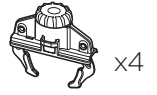

4

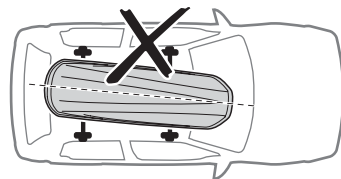
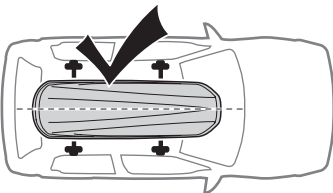
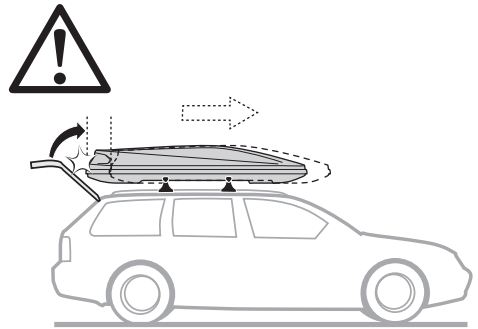
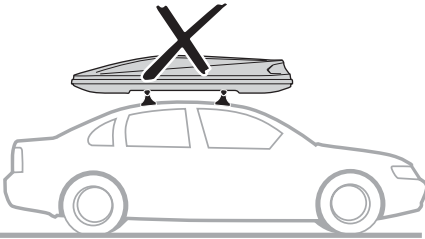

4

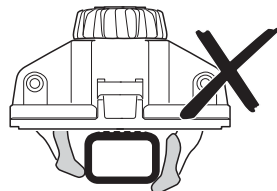
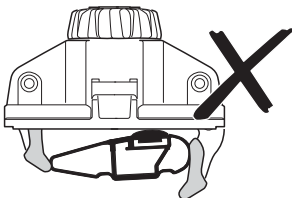
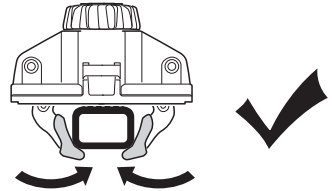
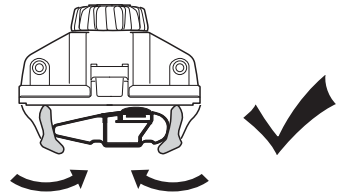
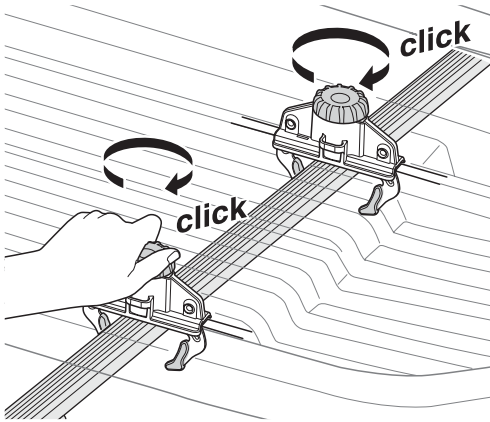
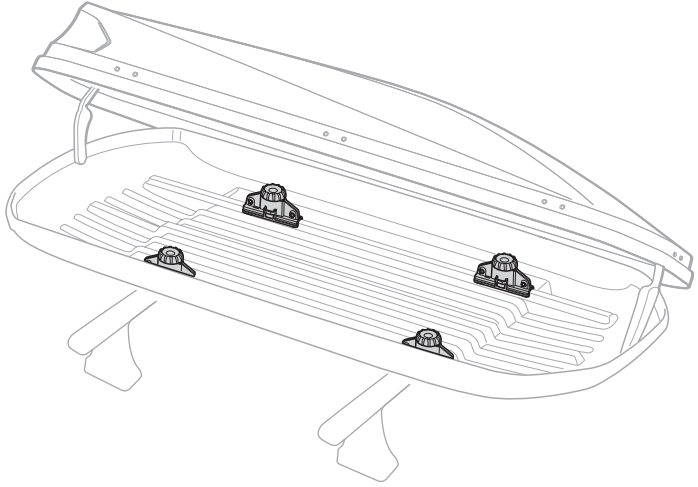



5



x 3

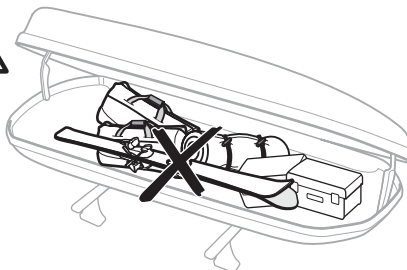
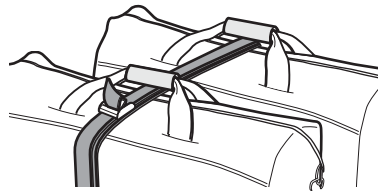
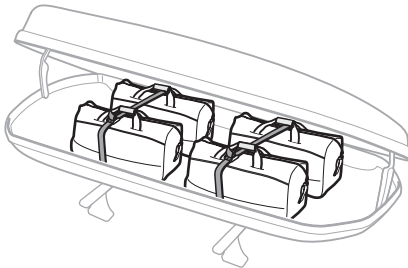
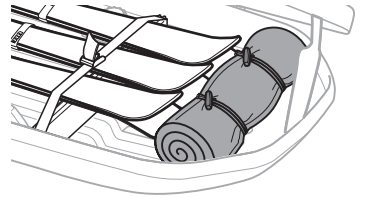
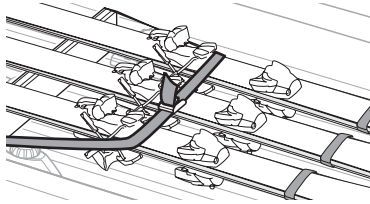
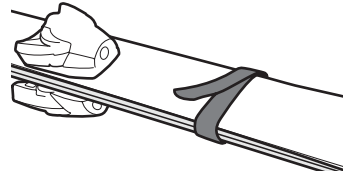
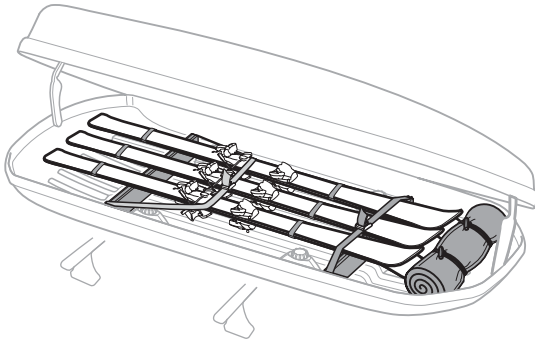
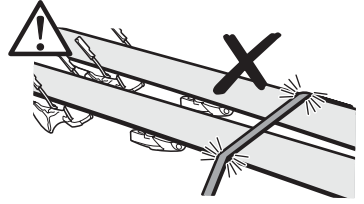
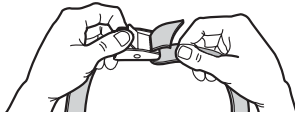

6

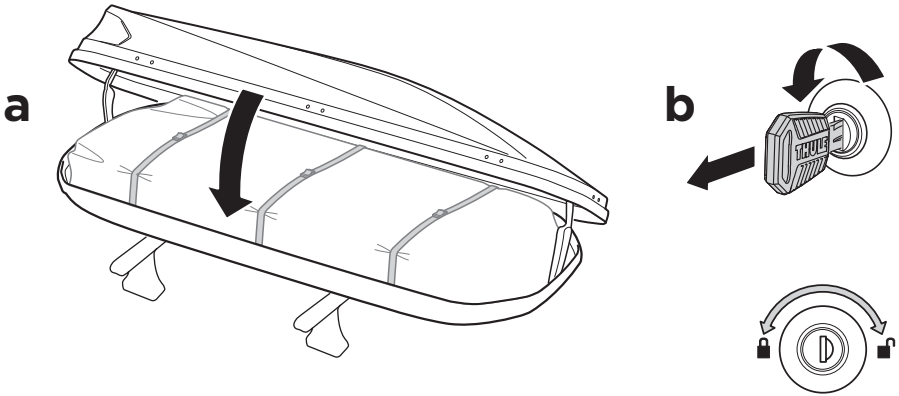

7

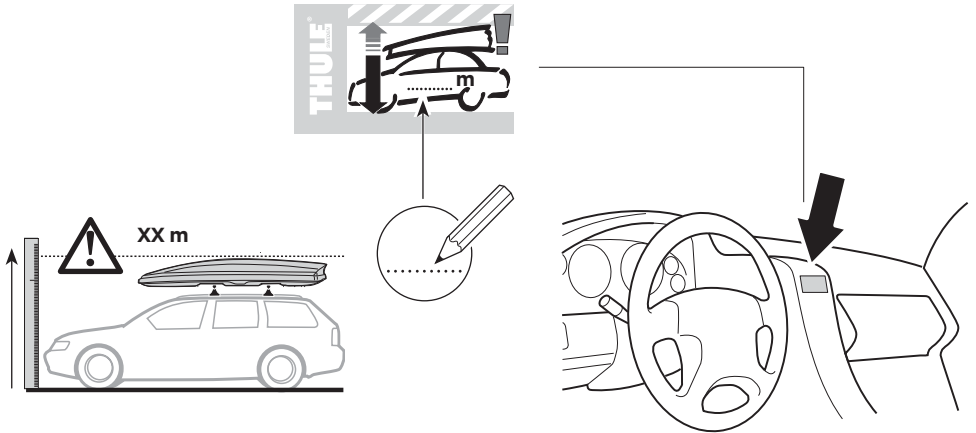

**EN** Accessories  
**DE** Zubehör  
**FR** Accessoires  
**NL** Accessoires  
**IT** Accessori  
**ES** Accesorios  
**PT** Acessórios  
**SV** Tillbehör

**DK** Tilbehør  
**NE** Tilbehør  
**FI** Lisävarusteet  
**ET** Lisavarustus  
**LV** Piederumi  
**LT** Priedai  
**PL** Akcesoria  
**RU** Аксессуары

**UK** Аксессуары  
**BG** Принадлежности  
**CS** Doplnky  
**SK** Príslušenstvo  
**SL** Dodatki  
**HR/BIH** Dodaci  
**RO** Accesorii  
**HU** Tartozékok

**EL** Εξαρτήματα  
**TR** Aksesuarlar  
**AR** الملحقات  
**HE** אביזרים  
**ZH** 附件  
**JA** アクセサリー  
**KO** 액세서리  
**TH** อุปกรณ์เสริม

## Thule Box Light

**695100**

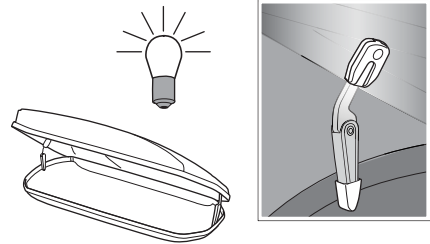
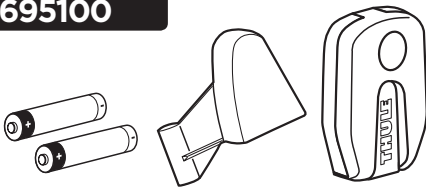

## Thule Box Lid Cover

**698100**



Touring 100/S  
Touring 200/M  
Touring 780/L



**698200**



Touring 600/Sport  
Touring 700/Alpine



## Thule T-track Adapter

**696400**



24x30 mm

**697400**



20x27 mm

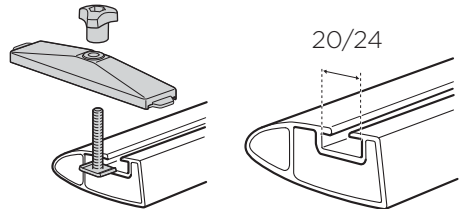

## Thule Box Ski Carrier Adapter

**694600**



Touring 600/Sport

**694700**



Touring 700/Alpine

**694800**



Touring 200/M  
Touring 780/L

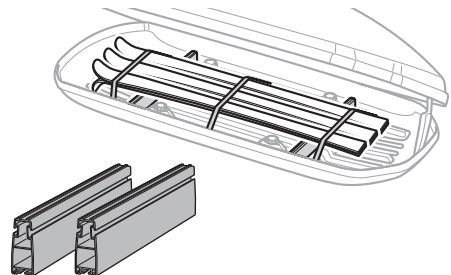

# Thule MultiLift

**572004**

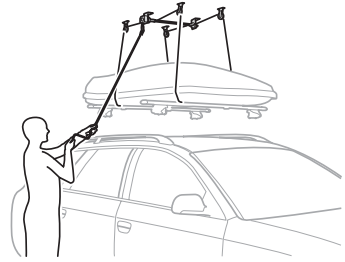
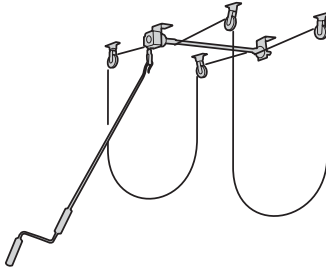

## Thule One-Key System

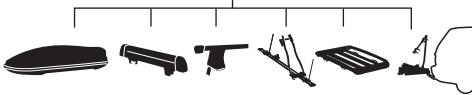

**450400**  (x4)

**450600**  (x6)

**450800**  (x8)

**451200**  (x12)

**451600**  (x16)

**1**

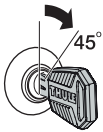

**2**



**3**

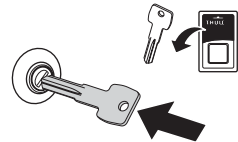

**4**

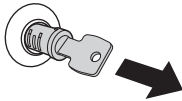

**5**

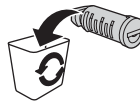

**6**

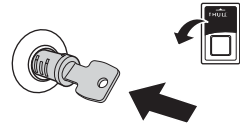

**7**

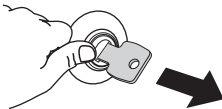

**8**

