

**MANIA** 400

**MANIA** 460

**MANIA** 580

**APACHE** 400

**APACHE** 460

**APACHE** 580

**I** Istruzioni per il montaggio

**GB** Fitting instructions

**D** Montageanleitung

**F** Instructions de montage

**E** Instrucciones de montaje

**NL** Montage-instructies

**PT** Instruções de Montagem

**S** Monteringsanvisning

**FIN** Asennusohje

**EST** Paigaldusjuhend

**LAT** Stiprināšanas instrukcija

**LIT** Pritvirtinimo instrukcijos

**PL** Instrukcja montażu

**RU** Инструкции по установке

**CZ** Návod na montáž

**SK** Návod na montáž

**SLO** Navodila za pritrjevanje

**HR** Uputa za sastavljanje

**HU** A felszerelés módja

**GR** Οδηγίες συναρμολόγησης

**DK** Monteringsvejledning

**RO** Instrucțiuni de montare







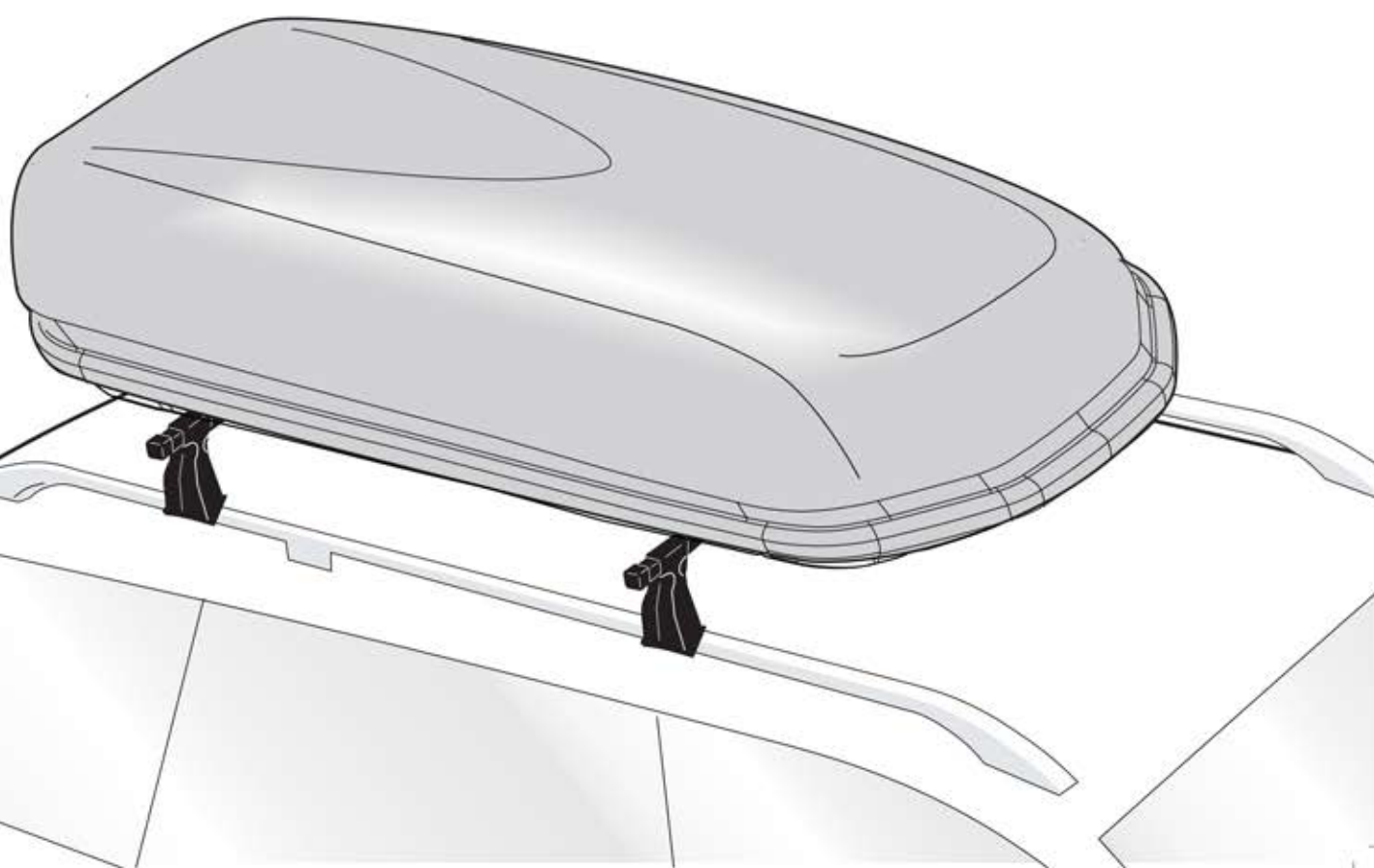

**TK** Uydurma talimat

**N** Monteringsveiledning

**中文** 裝修指導

**العربية** تعليمات التجميع





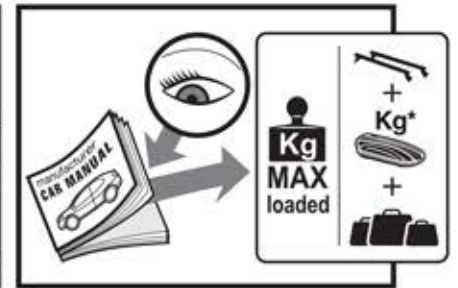
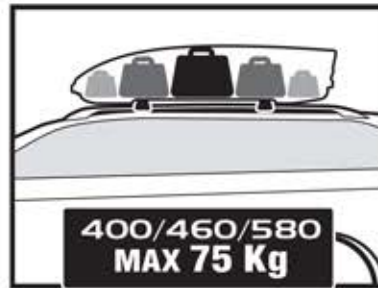



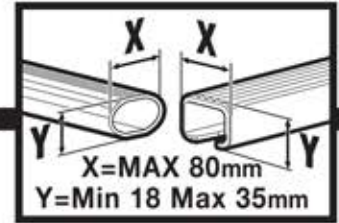























Model	 <b>400</b>	 <b>460</b>	 <b>580</b>
 Kg	75	75	75
 = Kg	15	17	20
Fixing			



## MANIA / APACHE 400-460



N.	<ul style="list-style-type: none"> <li> Componenti (Inclusi)</li> <li> Components (Included)</li> <li> Composants (Comprises)</li> <li> Die Komponenten (im Lieferumfang enthalten)</li> <li> Componentes (Incluido)</li> <li> Компоненты (в комплекте)</li> </ul>	Q.
1		1
2	 <b>SX</b>	1
3	 <b>DX</b>	1
4		4
5		4
6		4
7		4
8		4

N.	<ul style="list-style-type: none"> <li> Ricambi (A Richiesta)</li> <li> Spare Parts (Made to order)</li> <li> Pièces de rechange (Sur commande)</li> <li> Teile auf Anfrage</li> <li> Piezas de recambio (Previa solicitud)</li> <li> Запасные части (по запросу)</li> </ul>	Q.	Codice Code Code Code Código код
2	 <b>SX</b>	1	700000100000
3	 <b>DX</b>	1	700000200000
4		1	700000700000
5		1	700000500000
6		1	700000600000
7		1	700000900000
8		1	700001000000
13	 <b>XXXX</b>	1	700001200000
A		1	700000800000
B		1	700001100000

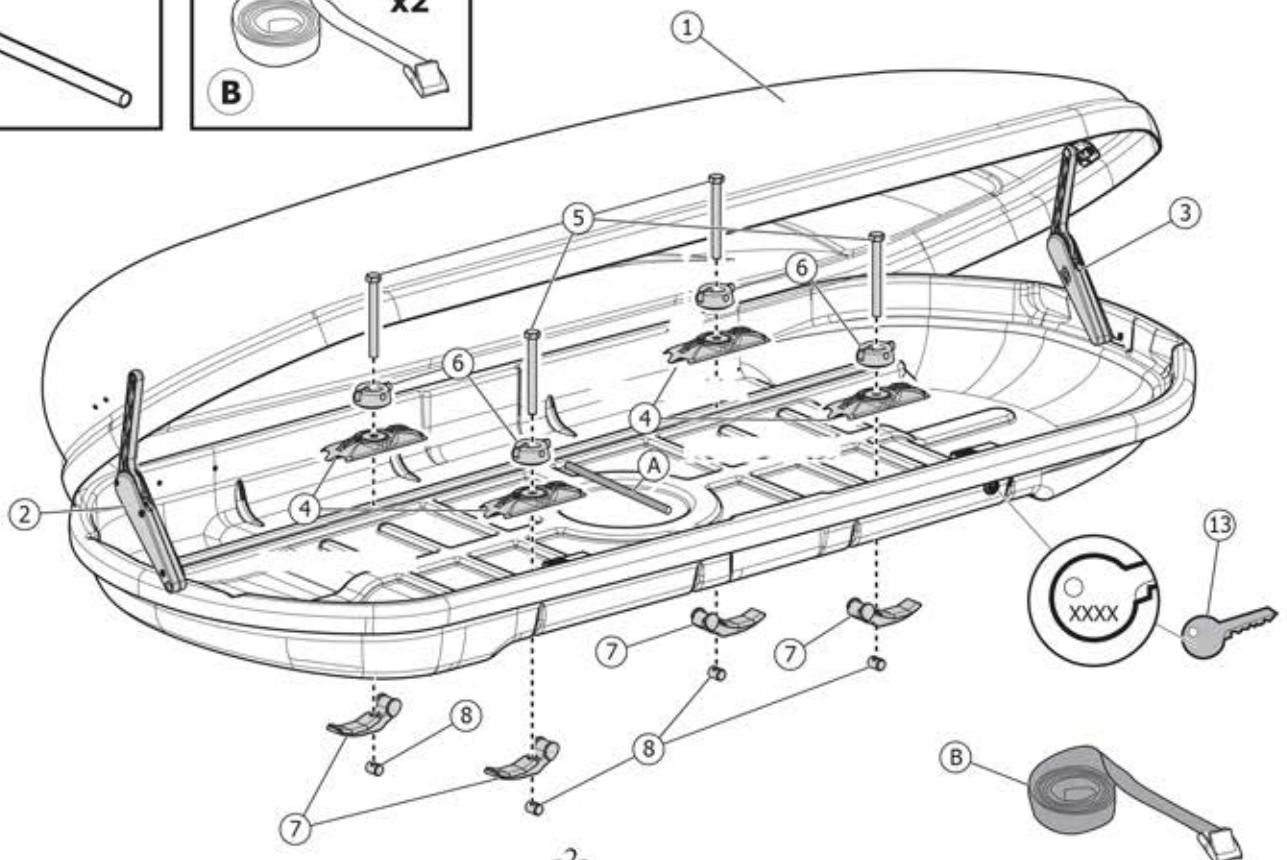
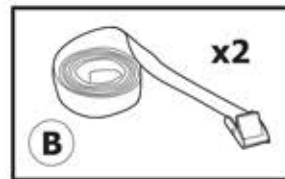
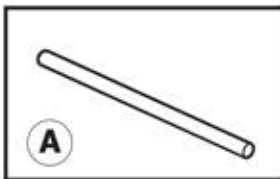

# MANIA / APACHE 460 DUO-580-580 DUO

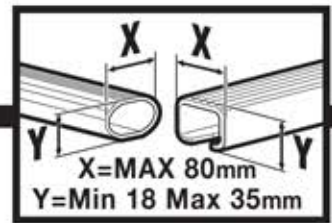

N.	<ul style="list-style-type: none"> <li>1 Componenti (Inclusi)</li> <li>2 Components (Included)</li> <li>3 Composants (Comprises)</li> <li>4 Die Komponenten (im Lieferumfang enthalten)</li> <li>5 Componentes (Incluido)</li> <li>6 Компоненты (в комплекте)</li> </ul>	Q.
1		1
2	SX	1
3	DX	1
4		4
5		4
6		4
7		4
8		4

N.	<ul style="list-style-type: none"> <li>1 Ricambi (A Richiesta)</li> <li>2 Spare Parts (Made to order)</li> <li>3 Pièces de rechange (Sur commande)</li> <li>4 Teile (auf Anfrage)</li> <li>5 Piezas de recambio (Previa solicitud)</li> <li>6 Запасные части (по запросу)</li> </ul>	Q.	Codice Code Code Code Código код
2	SX	1	700000300000
3	DX	1	700000400000
4		1	700000700000
5		1	700000500000
6		1	700000600000
7		1	700000900000
8		1	700001000000
13	XXXX	1	700001200000
A		1	700000800000
B		1	700001100000

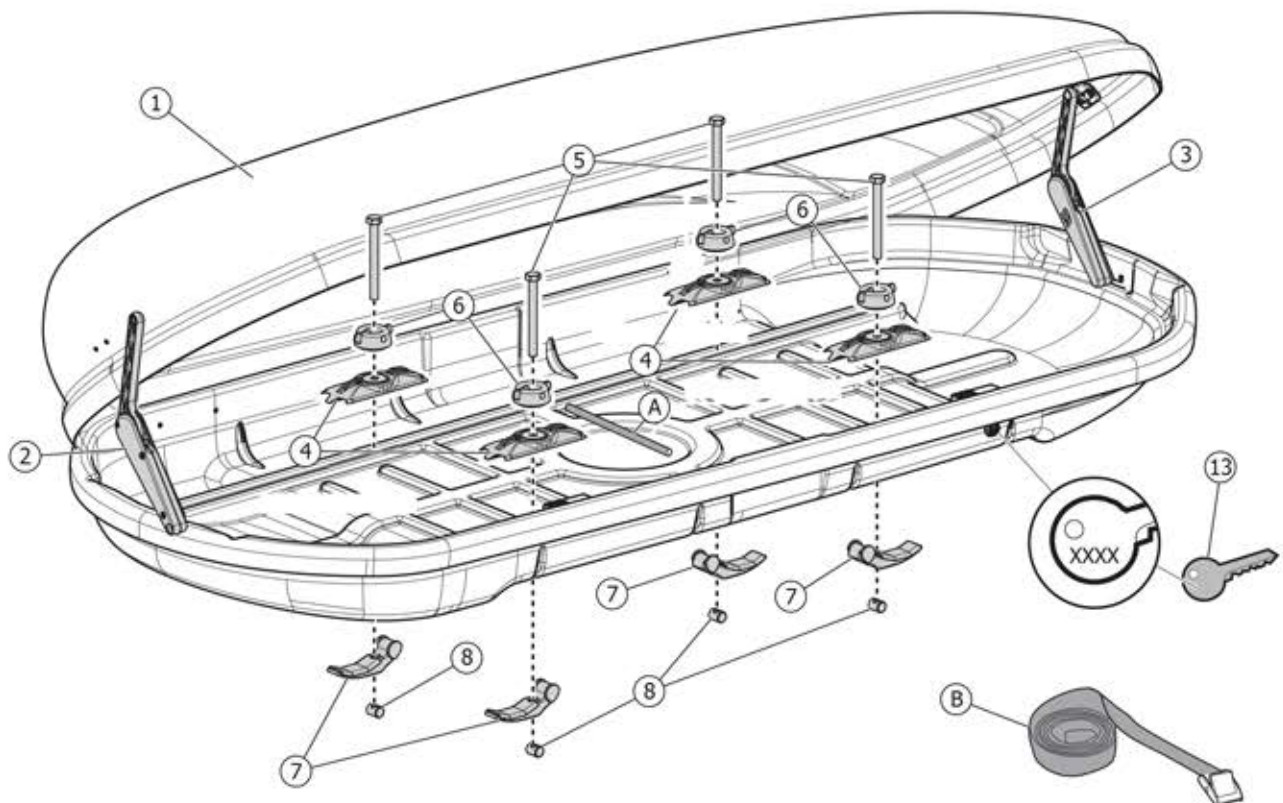
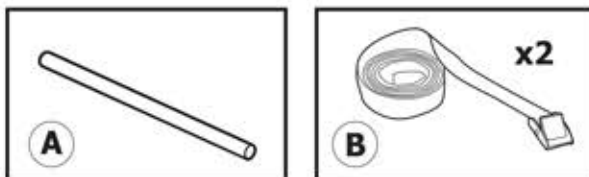

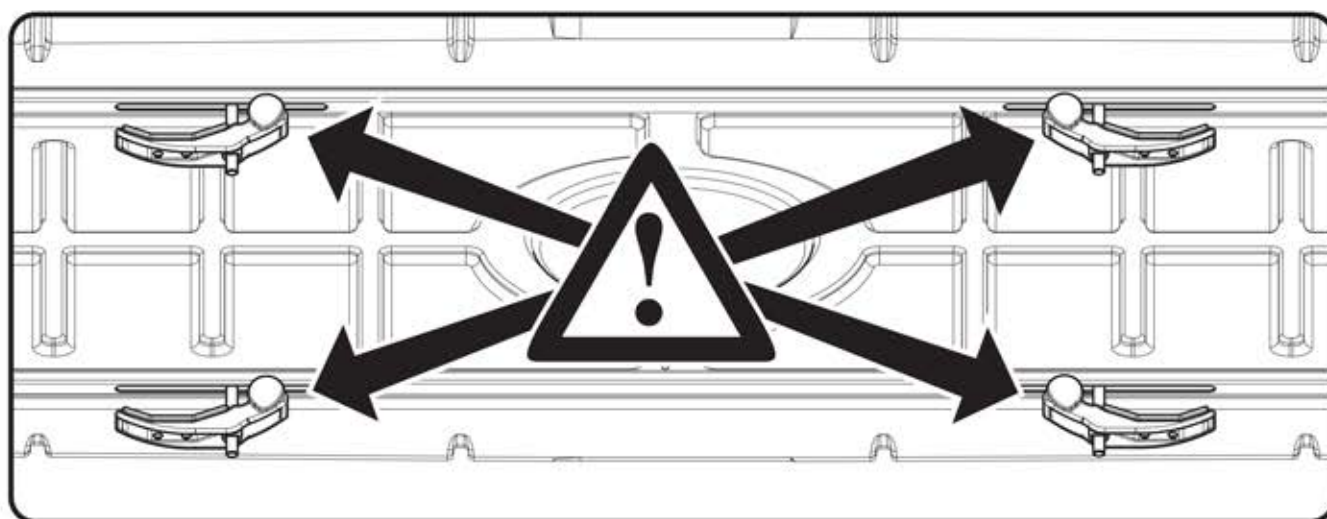
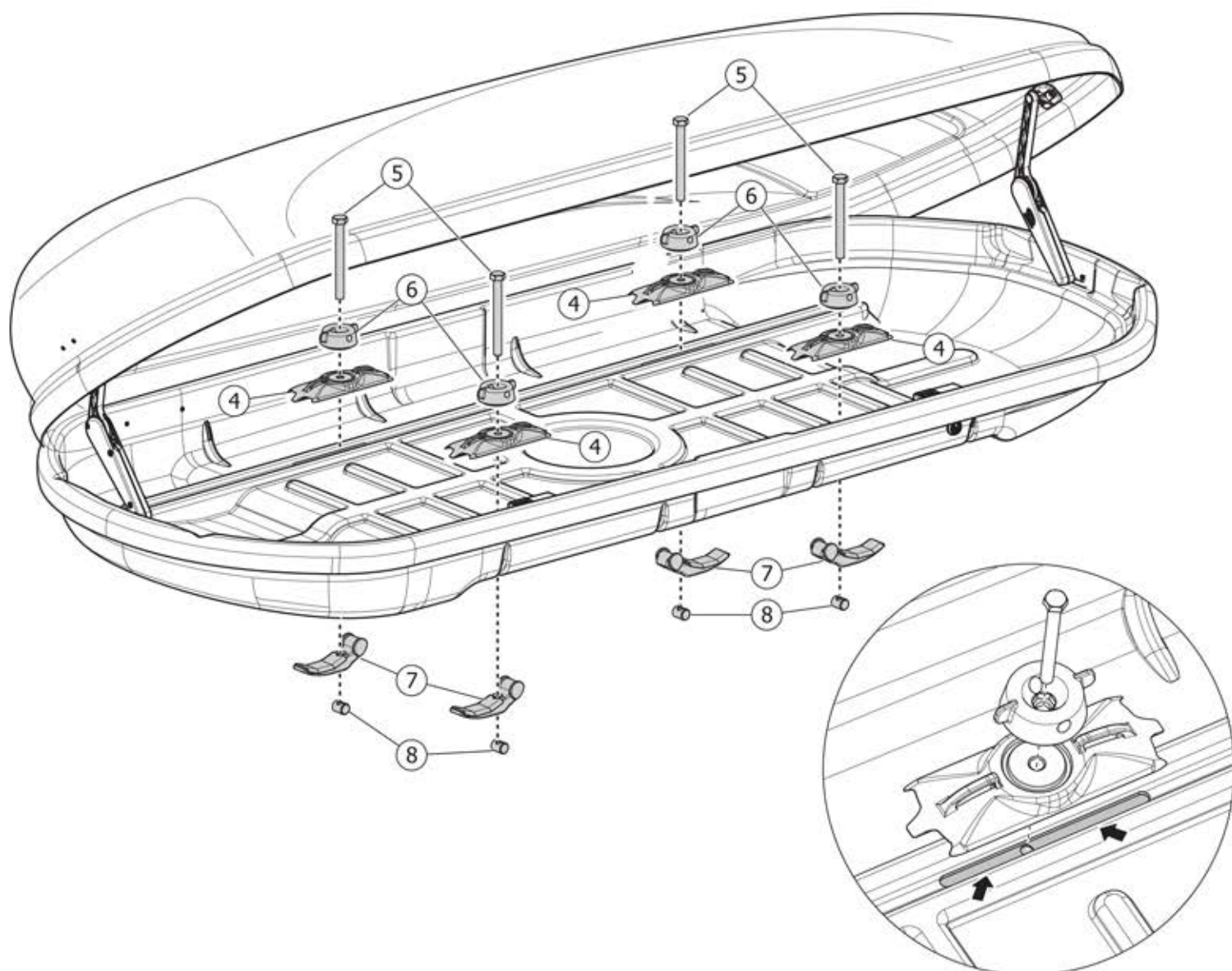

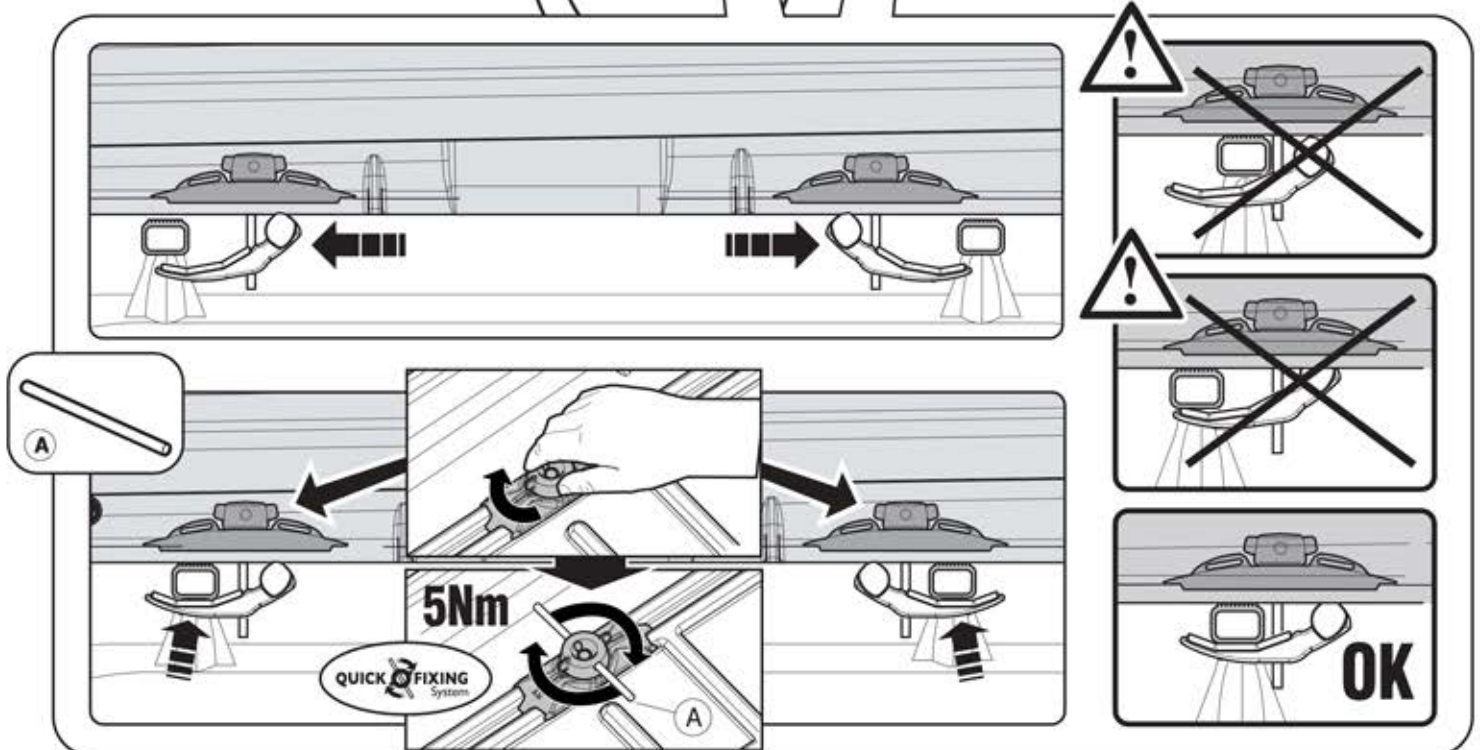
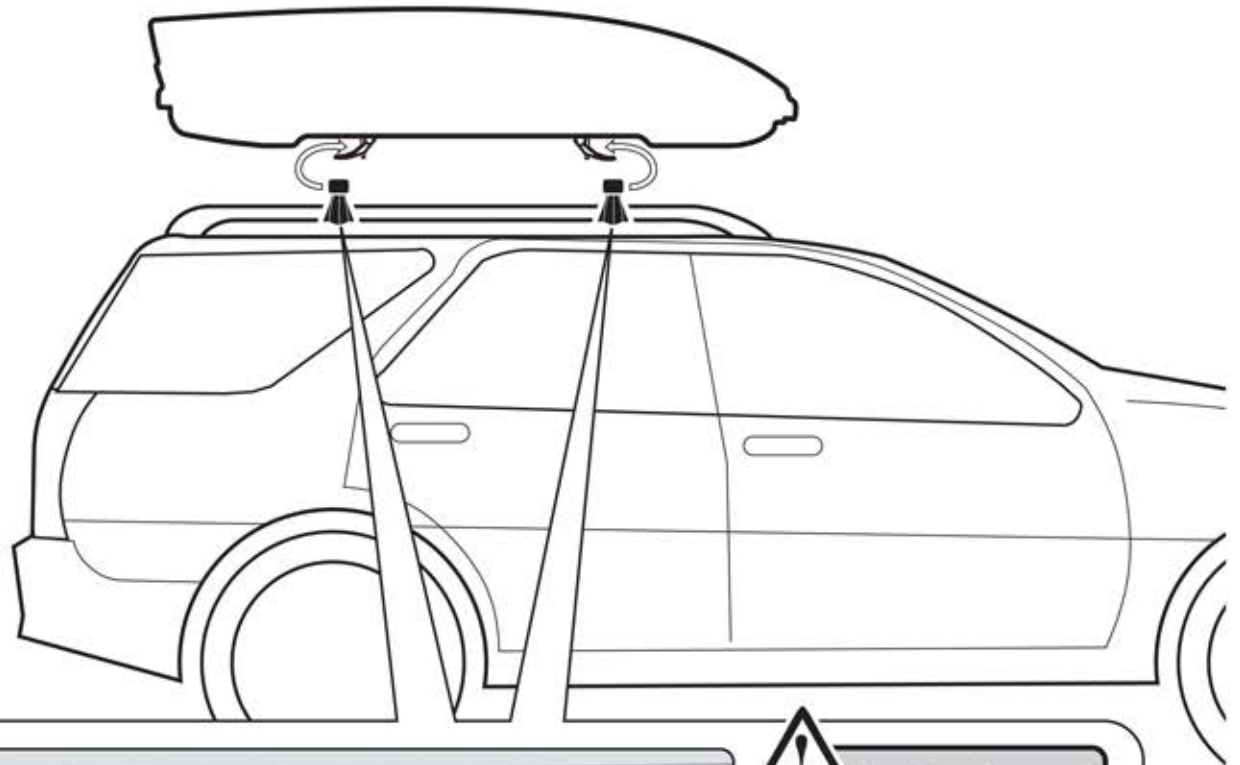
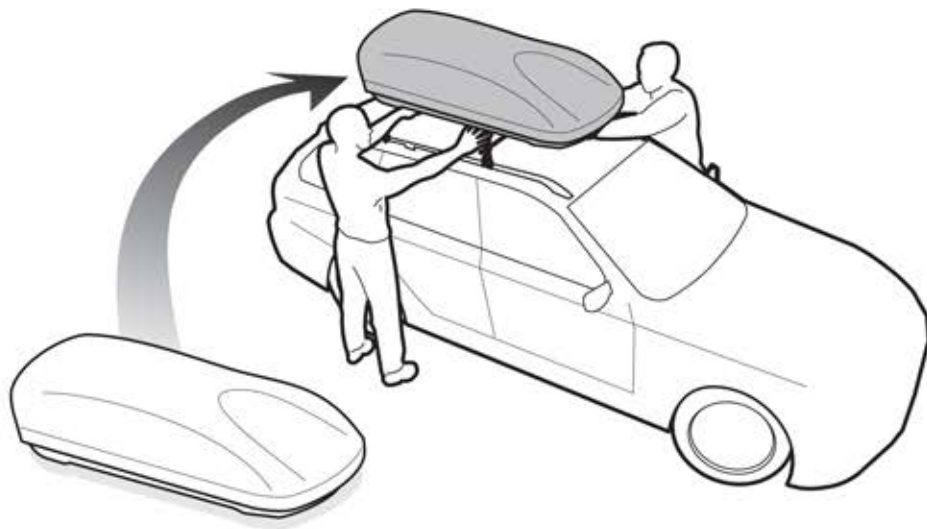

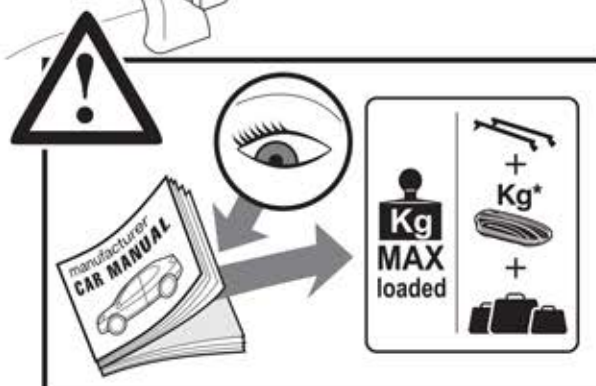
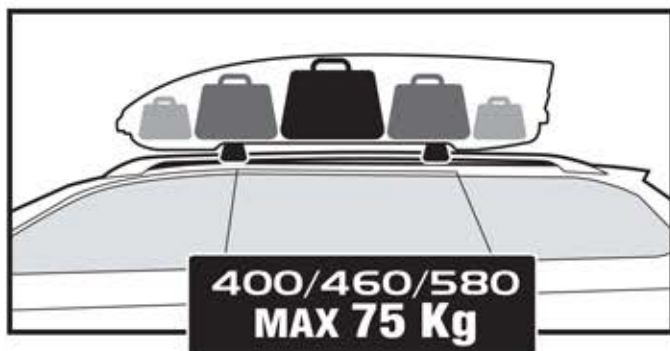
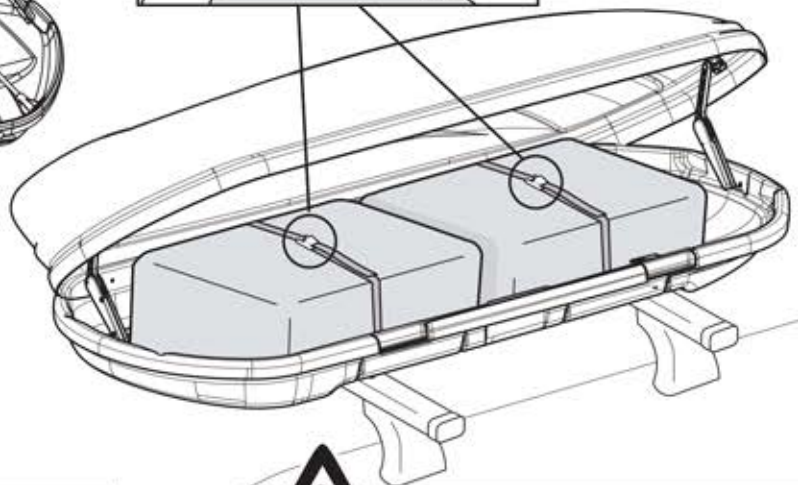
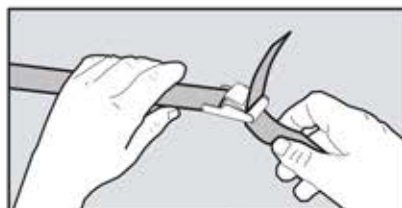
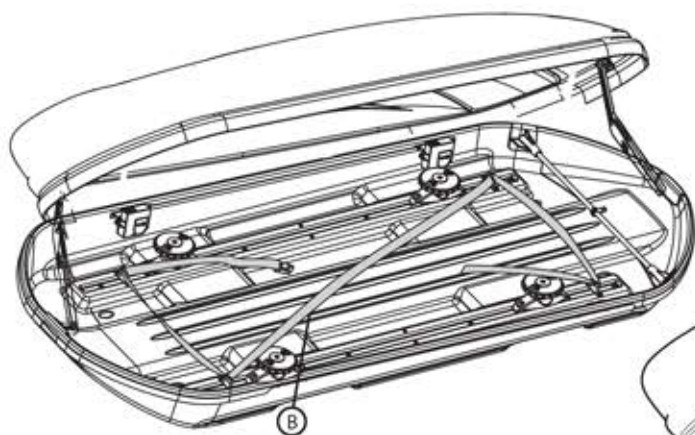
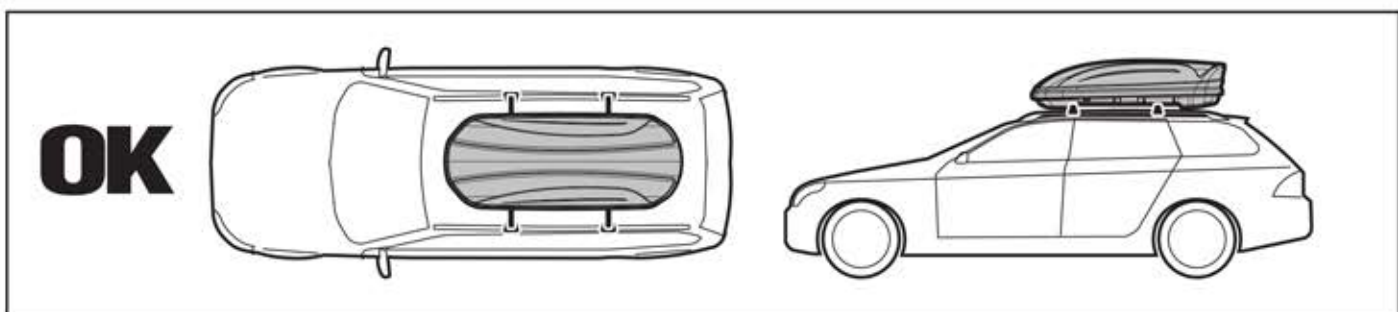
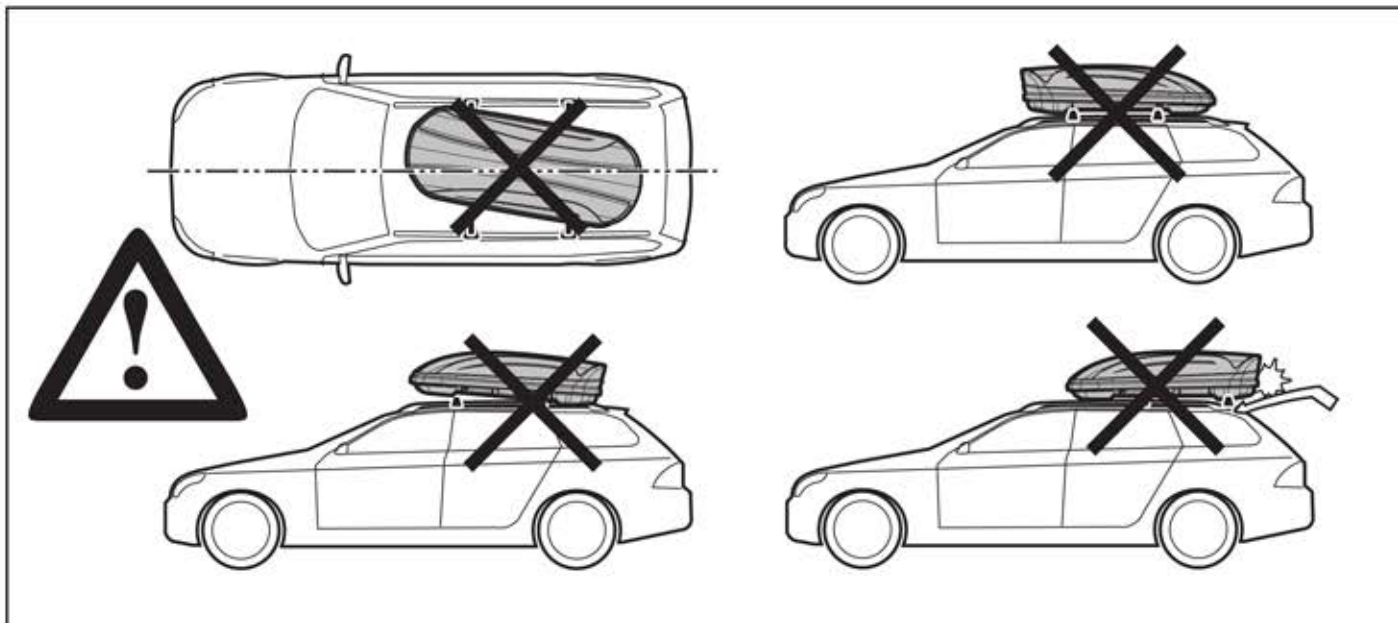

400 = 15 Kg    460 = 17 Kg    580 = 20 Kg

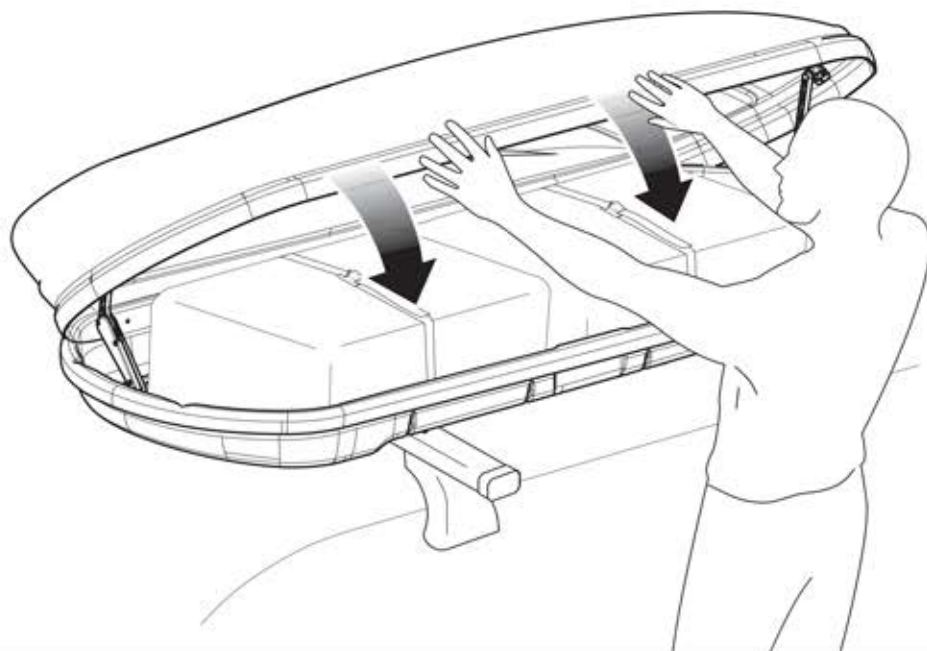

**OK**

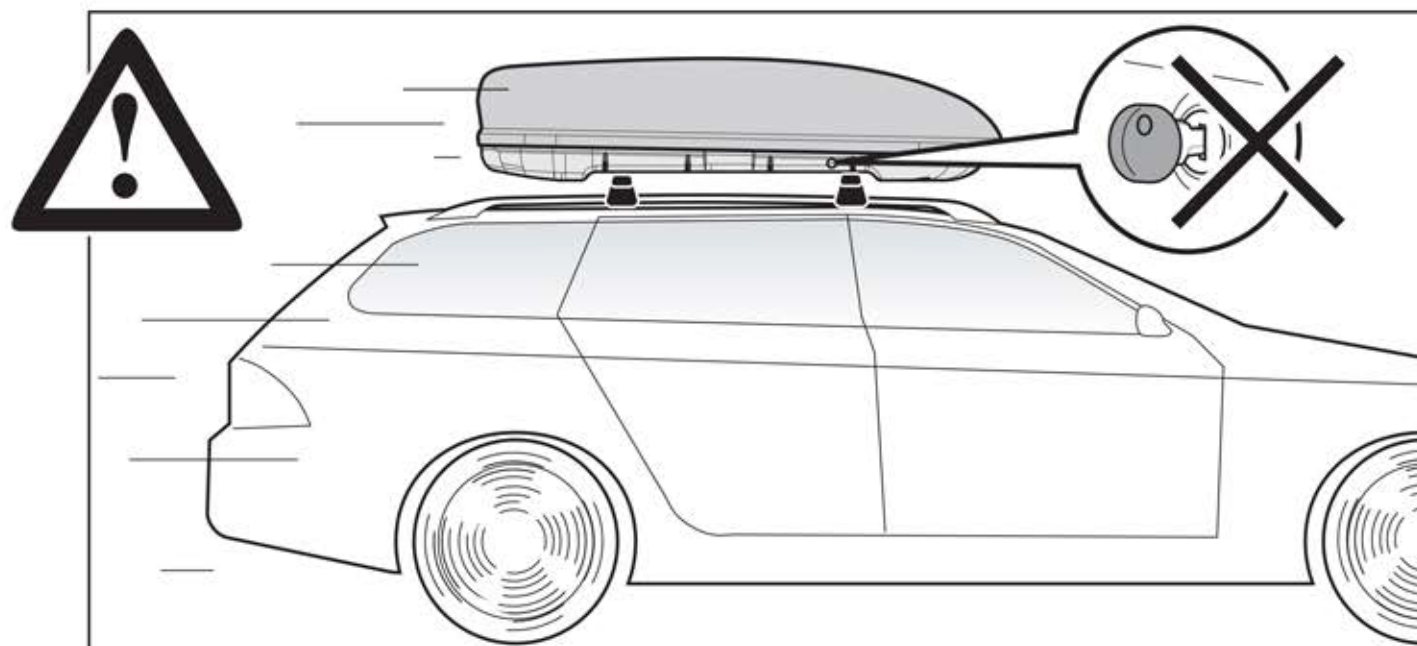
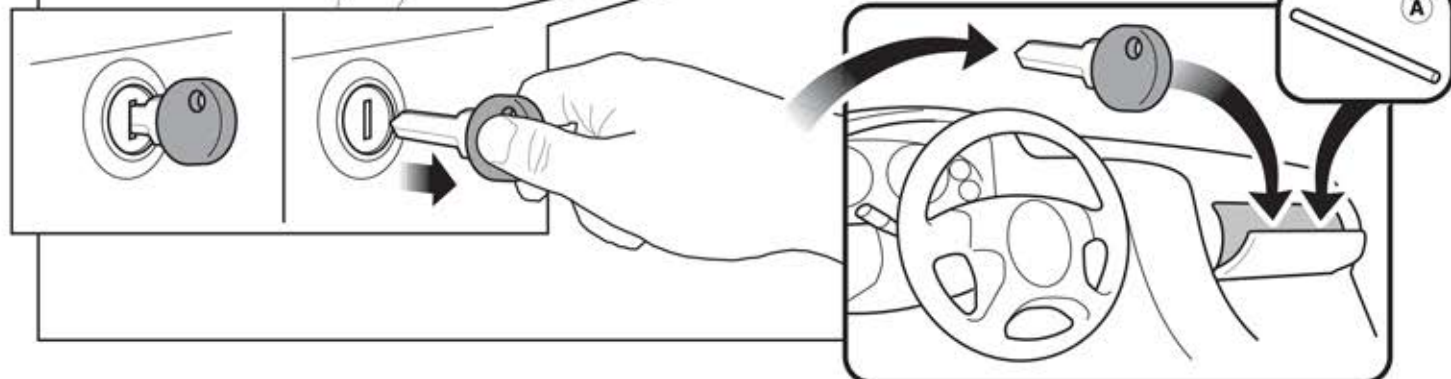
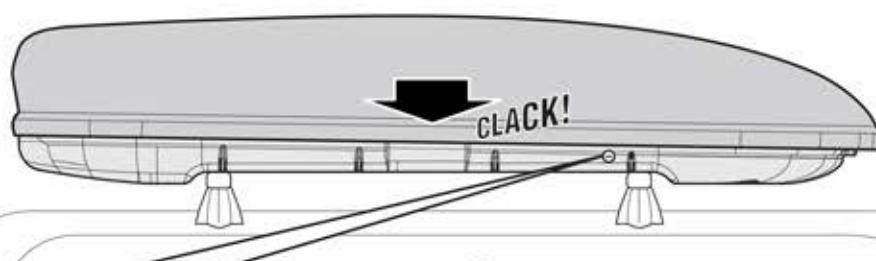

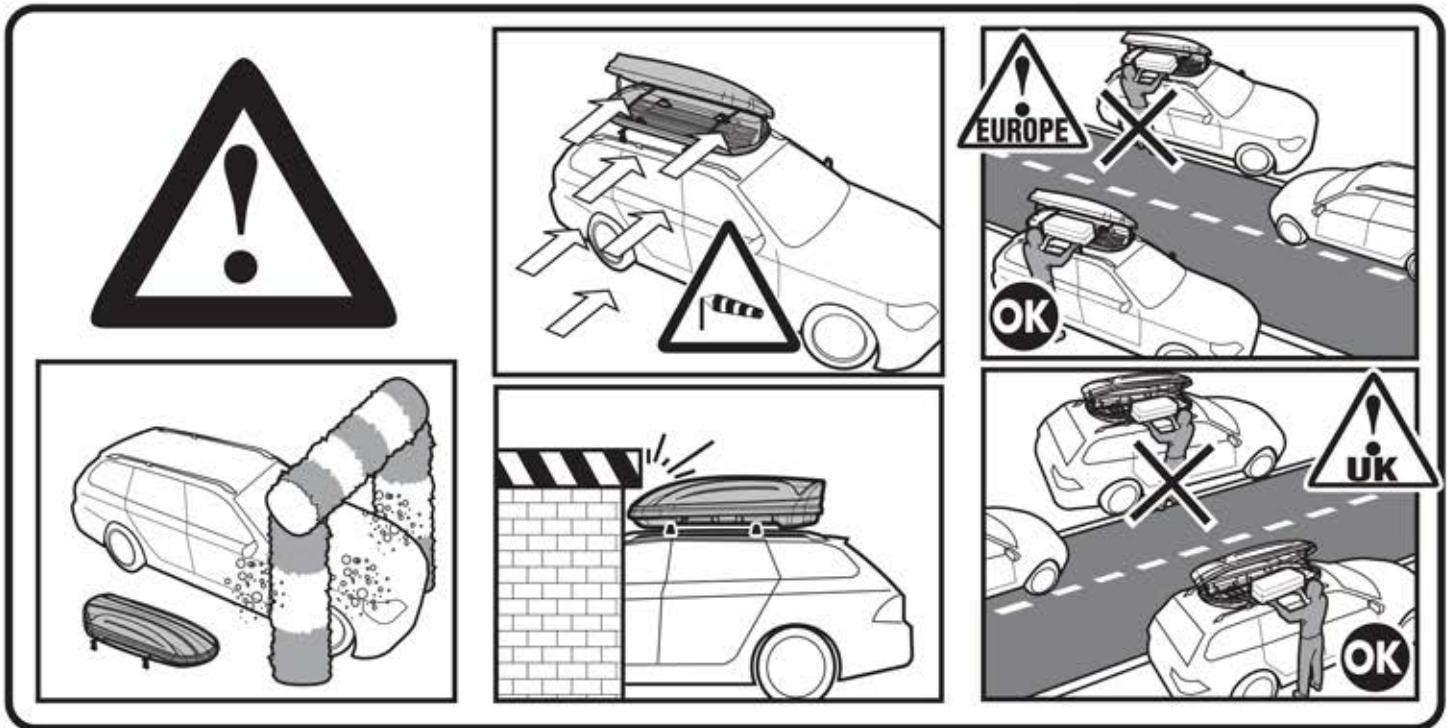
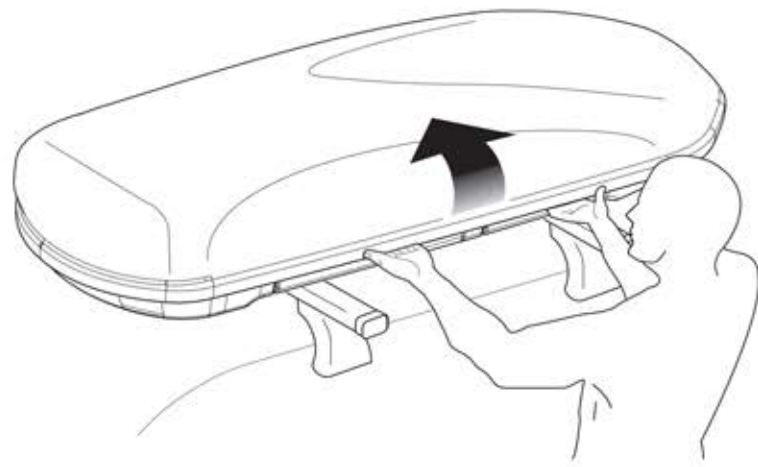
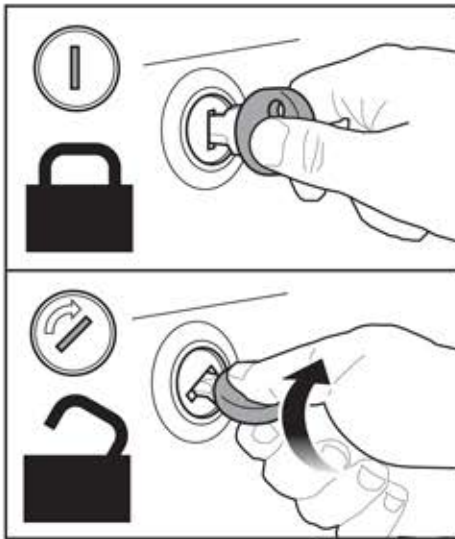

**OPTIONAL KIT**

000063600000

20mm

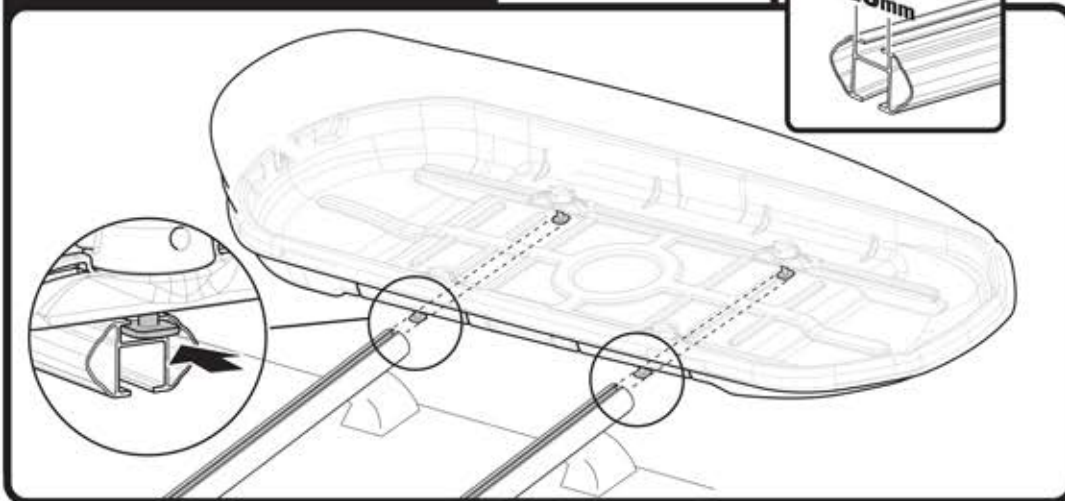

Cod. istr.	Data	Creato da	Approvata da
100034200001	31/05/2016	NP	EL

Fabbricato da:  
**F.lli Menabò S.r.l.**  
 Via 8 Marzo, 3  
 I- 42025 Cavriago (RE)  
 Tel. +39-0522/942840  
 Fax. +39-0522/942948  
 e-mail: info@flli-menabo.it  
 www.flli-menabo.it  
 www.m-way.it

